

# **International**



## **Safety Competition**

### **EVENT LAYOUT**

**EVENT LAYOUT:**

Each of the following sections includes the title of the event and layout instructions. The better understanding the contestants have of the events, the more successful they are likely to be during the competition.

**Contents**

OFFSET ALLEY EVENT ..... 2

RAILROAD GRADE CROSSING – RIGHT TURN..... 5

STRAIGHT LINE EVENT ..... 6

DIMINISHING CLEARANCE EVENT ..... 7

BACK UP STALL EVENT ..... 8

LEFT TURN EVENT ..... 10

PARALLEL PARKING EVENT ..... 11

ELEMENTARY STUDENT LOADING EVENT..... 12

CURB LINE PARKING EVENT..... 13

STOP LINE EVENT ..... 14

BUS MEASURING POINT CHART ..... 15

**OFFSET ALLEY EVENT**

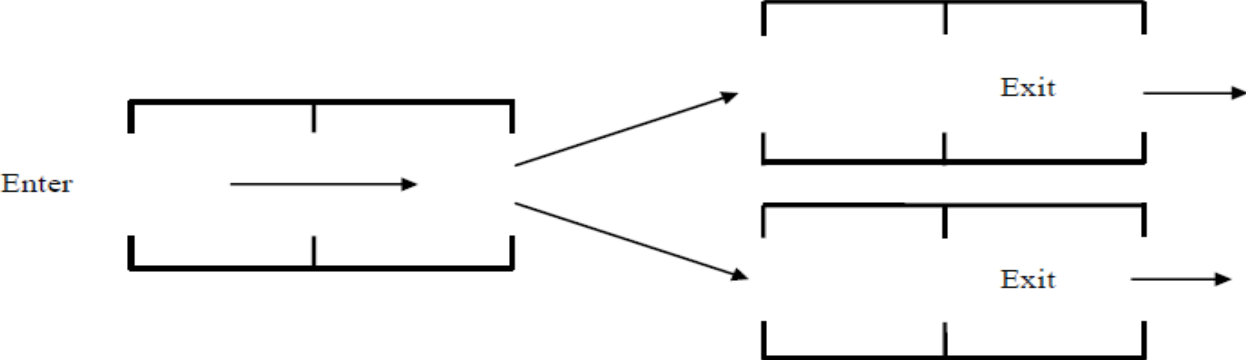

## LAYOUT & DIRECTIONS:

### Setup Tools for Offset Alley:

- Heavy-duty claw hammer
- 1½ inch masonry nails (one box)
- Two 25 ft. tape measures
- One 100 ft. tape measure
- One 1000 ft. roll of nylon string
- One box of yellow marker crayons
- Carpenter's Square
- Four to Six 10' barriers w/flag tips
- Other

## Single Offset Alley Layout

Nail # 1 - Starting point.  
Nail # 2 - Stretch string 120' from nail # 1 and tie off.

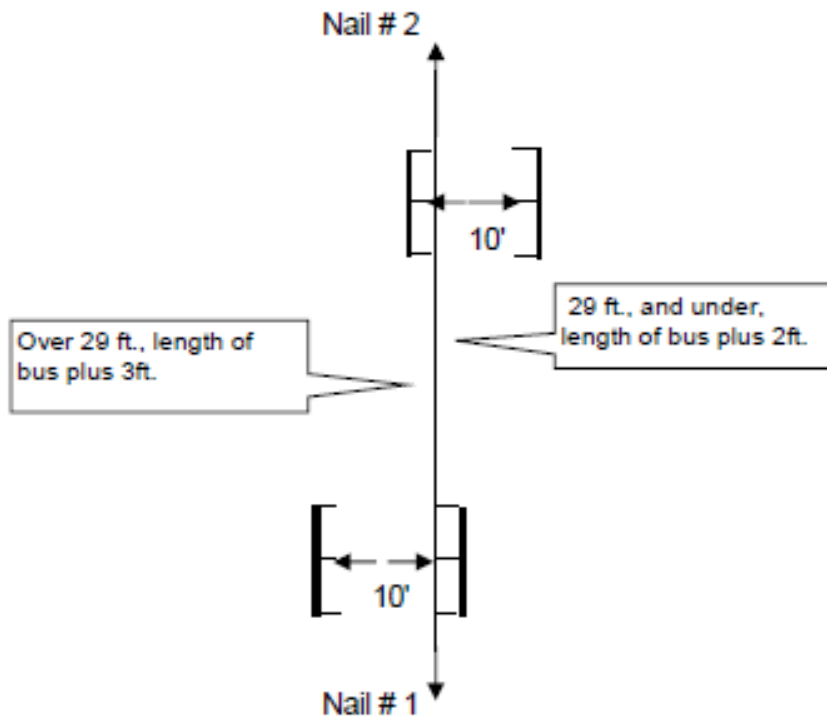

**LAYOUT & DIRECTIONS:**

**Double Offset Alley Layout**

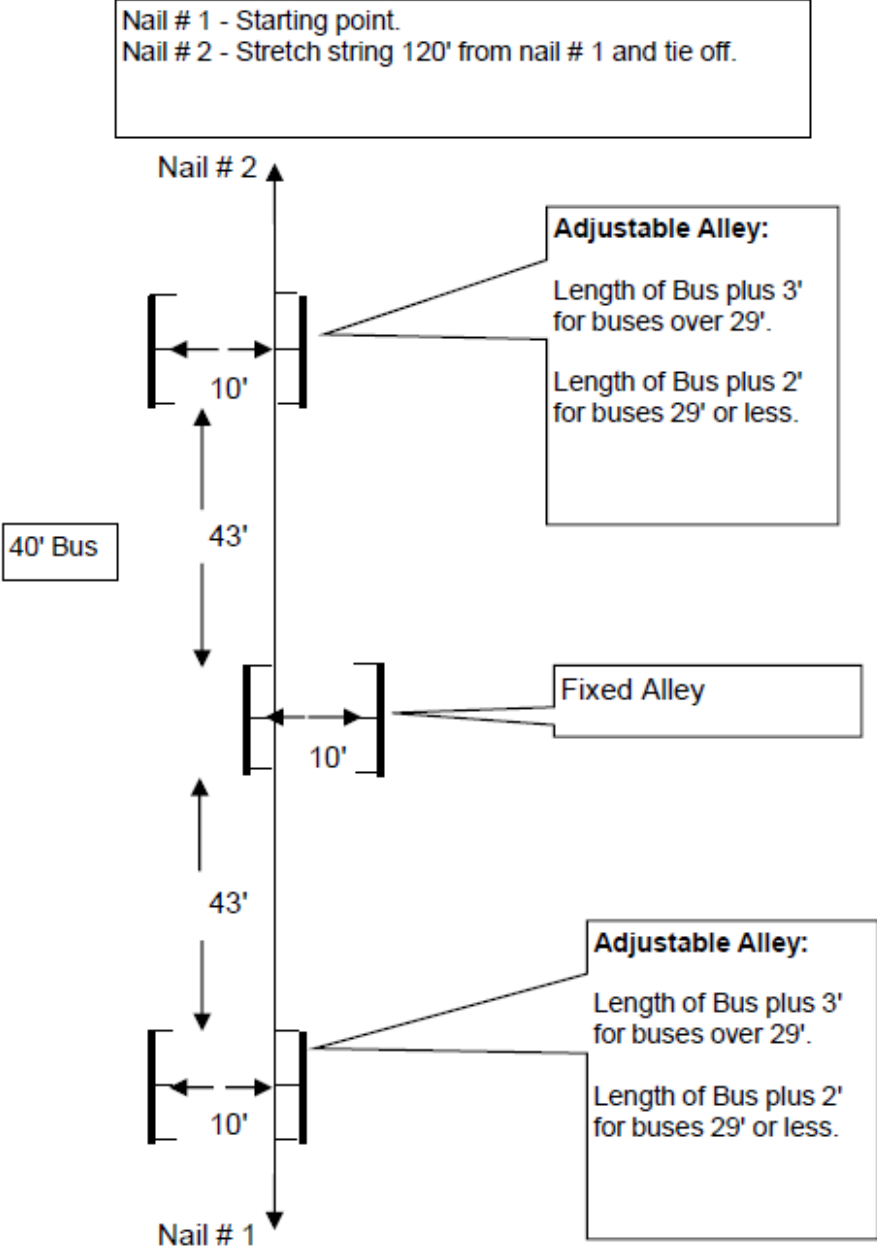

# RAILROAD GRADE CROSSING – RIGHT TURN

## LAYOUT & DIRECTIONS:

### RXR Grade Crossing - Right Turn Template to Template Set-Up SAMPLE

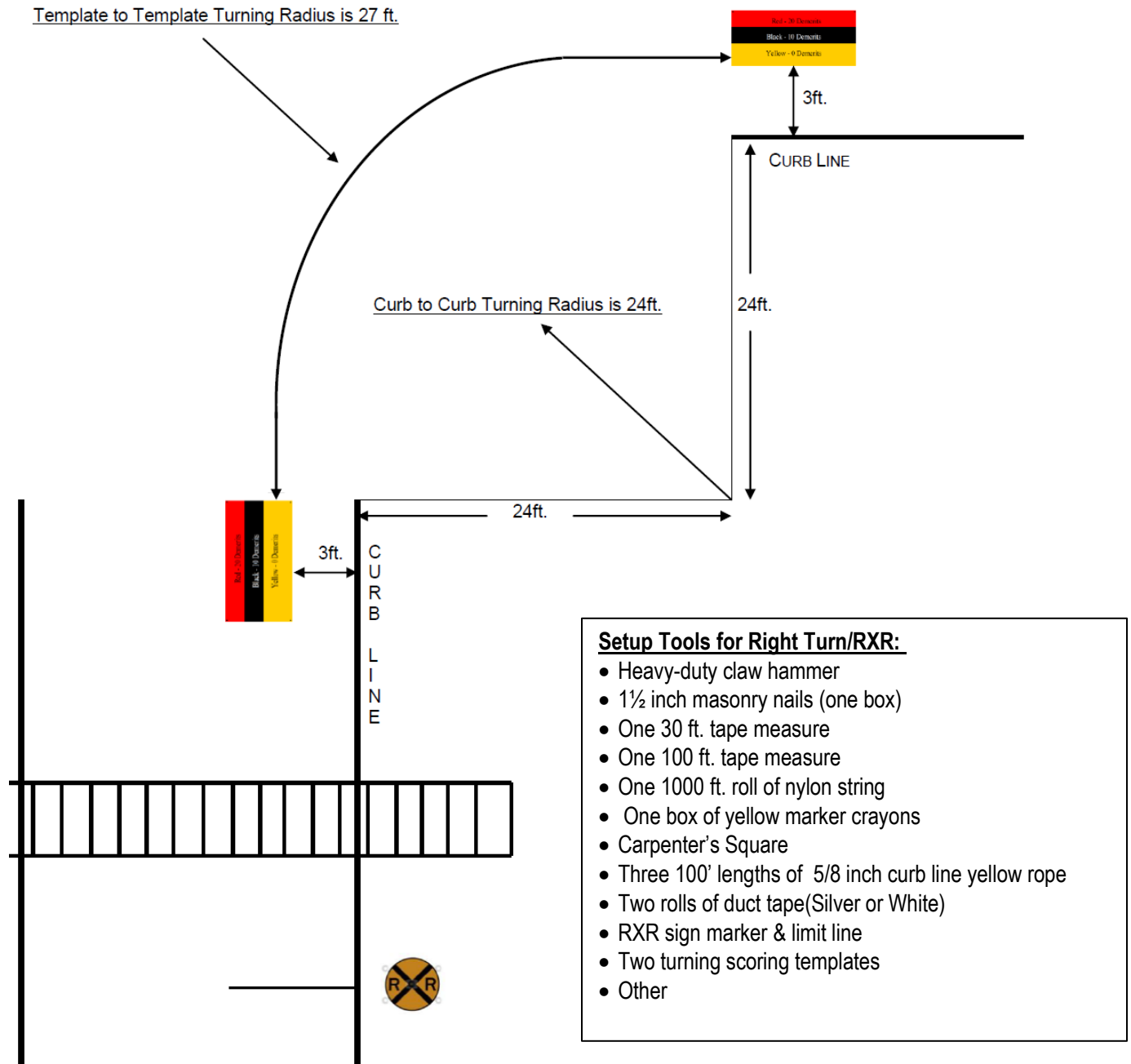

# STRAIGHT LINE EVENT

## LAYOUT & DIRECTIONS:

### DIRECTIONS:

1. Measure a 75 ft. straight line and string.
2. Mark the line in intervals of 25 ft. with crayon or chalk.
3. Place a set of tennis balls on holders every 25 ft. Set the base of the ball holder on the outside edge of the string line.
4. Secure the measurement of the right rear duals of all vehicles used in competition. The measurement shall be from bulge to bulge. Tire sizes must be the same type if more than one vehicle type is used.
5. Use the measurement of the duals plus 3" to determine distance between balls.
6. Measure the alignment of the tennis balls from the inside edge of the tennis ball to the inside edge of the other tennis ball.
7. Make a visual check to be sure that there is a perfect straight line with the four sets of tennis balls.
8. Mark the location of the tennis ball holders with crayon or chalk.

### Setup Tools for Straight Line:

- Heavy-duty claw hammer
- 1½ inch masonry nails (one box)
- One 12 ft. tape measure
- One 100 ft. tape measure
- One 1000 ft. roll of nylon string
- One box of yellow marker crayons
- Carpenter's Square
- Ten tennis balls
- Ten tennis ball holders
- Other

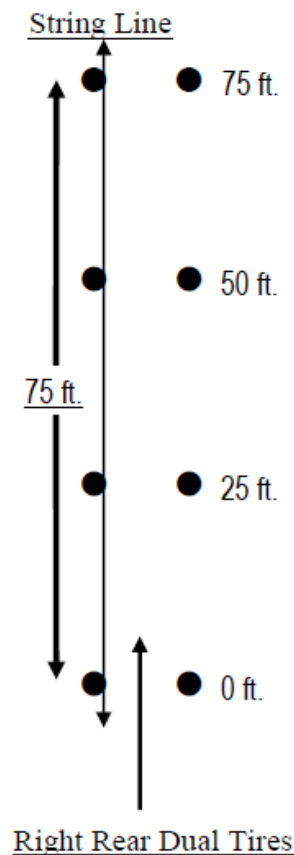

# DIMINISHING CLEARANCE EVENT

## LAYOUT & DIRECTIONS:

1. Measure a distance of 100'
2. Mark the measurement at 25' intervals.
3. Place a straight line down with string. Stretch tight.
4. Secure width of buses to be used in competition. Consider rub rails, rubber around tire wells or any other object that will hit the standards such as mirror brackets, etc.
5. Determine the measurement to be used at each diminishing clearance standard.
6. Measure from the center line out to the end of the flag or standard on each side to equal the total measurement. To make sure the measurement is correct, use plumb bob from tip of flag to ground where measurement was made.
7. Do a visual check to make sure that you have a diminishing alley from the perspective of the contestant entering the offset.
8. Mark bases of the standards with crayons or chalk.

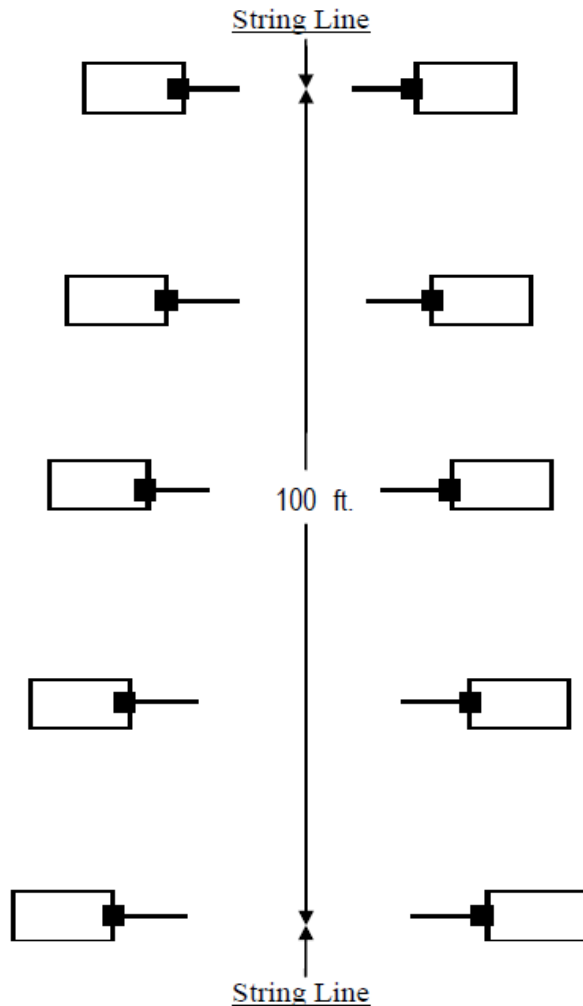

### Setup Tools for Diminishing Clearance

- Heavy-duty claw hammer
- 1½ inch masonry nails (one box)
- One 50 ft. tape measure
- One 100 ft. tape measure
- One 1000 ft. roll of nylon string
- One box of yellow marker crayons
- Carpenter's Square
- Plumb bob
- 10 diminishing clearance standards w/flag arms (36" high minimum)
- Other

1 <sup>st</sup> pair of standards	With of bus plus 10 inches
2 <sup>nd</sup> pair of standards	With of bus plus 8 inches
3 <sup>rd</sup> pair of standards	With of bus plus 6 inches
4 <sup>th</sup> pair of standards	With of bus plus 4 inches
5 <sup>th</sup> pair of standards	With of bus plus 2 inches



# BACK UP STALL EVENT

## LAYOUT & DIRECTIONS:

### Setup Tools for Backup Stall

- Heavy-duty claw hammer
- 1½ inch masonry nails (one box)
- One 30 ft. tape measure
- One 100 ft. tape measure
- Two 1000 ft. roll of nylon string
- One box of yellow marker crayons
- One roll of duct tape (Silver or Black)
- Carpenter's Square
- Four 100' lengths of 5/8 inch curb line yellow rope
- Two 25' lengths of 5/8 inch limit line yellow rope
- Two backup stall equipment setups.
- Two timer clocks
- Other

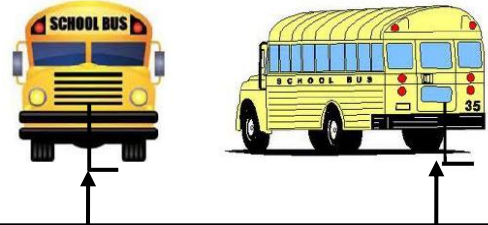

Measure from the front and rear bumper only.  
( DO NOT MEASURE FROM CROSSING CONTROL ARM.)

### Back-Up Stall - 10 Foot Wide Right Side of Bus Approach

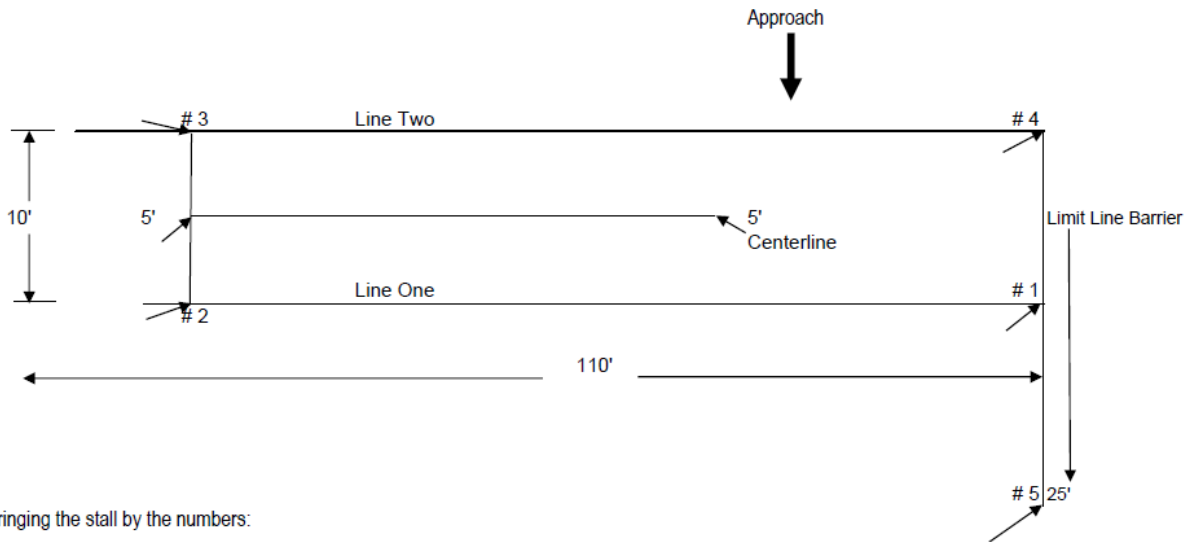

**Note:** Stringing the stall by the numbers:

Nail # 1 - Stall layout starting point.

Nail # 2 - Stretch the string 100' and nail # 2.

Nail # 3 - Measure 10' across, using a 90 degree carpenters square, square the stall using the string and tape measure between # 2 and # 3, when squared, nail # 3. Measure 5' and place nail in center of stall.

Nail # 4 - Stretch the string 100', square the stall using the string between # 1 and # 2, measure 10' and square the stall, nail # 4.

Nail # 5 - Stretch the string 35' aligning with the outside edge of # 1, nail and tie off.

## Back-Up Stall - 10 Foot Wide Right Side of Bus Approach

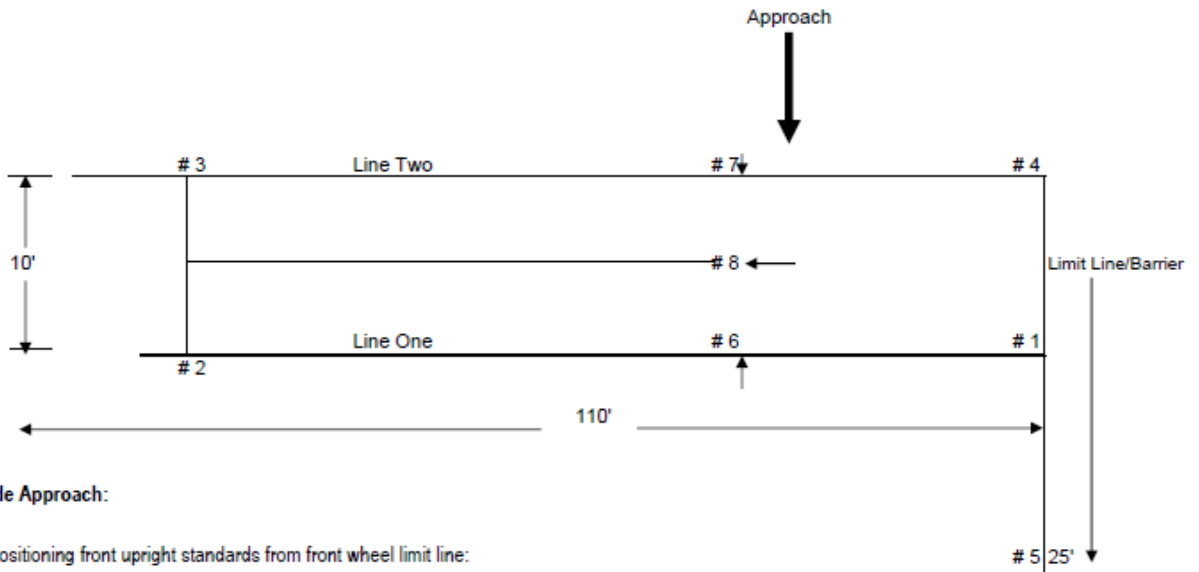

- Mark # 6 - Measure from # 1 using the length of the shortest bus plus 1' to 4' depending on the bus type and place # 6.
- Mark # 7 - Measure from # 4 using the length of the shortest bus plus 1' to 4' depending on the bus type and place # 7.
- Nail # 8 - Measure from the outside edge of # 6 to the outside edge of # 7. Nail # 8 @ 5' the center of the stall.

\*\*\*\*\*

## Back-Up Stall - 10 Foot Wide Right Side of Bus Approach

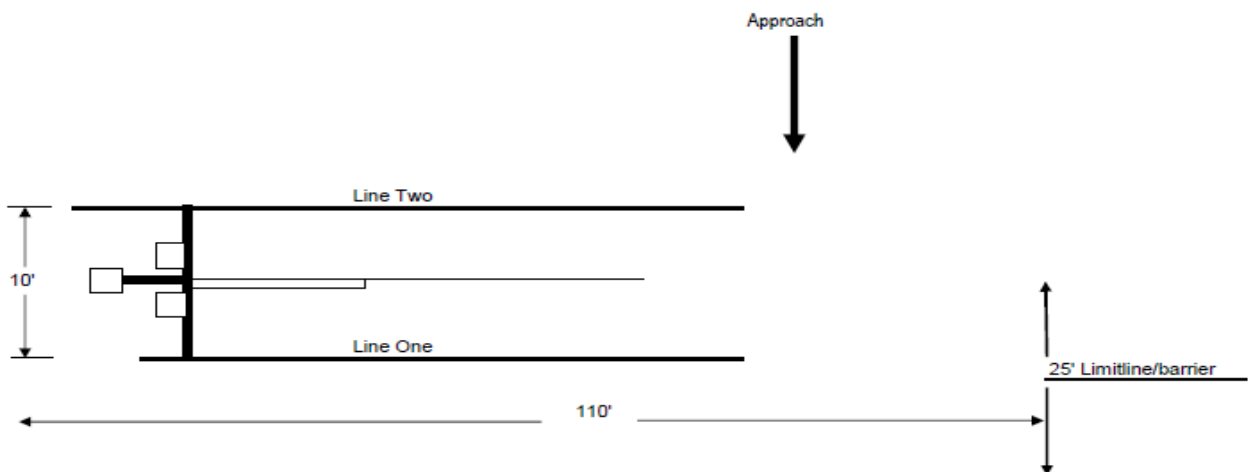

# LEFT TURN EVENT

## LAYOUT & DIRECTIONS:

### Left Turn Template to Template Set-Up

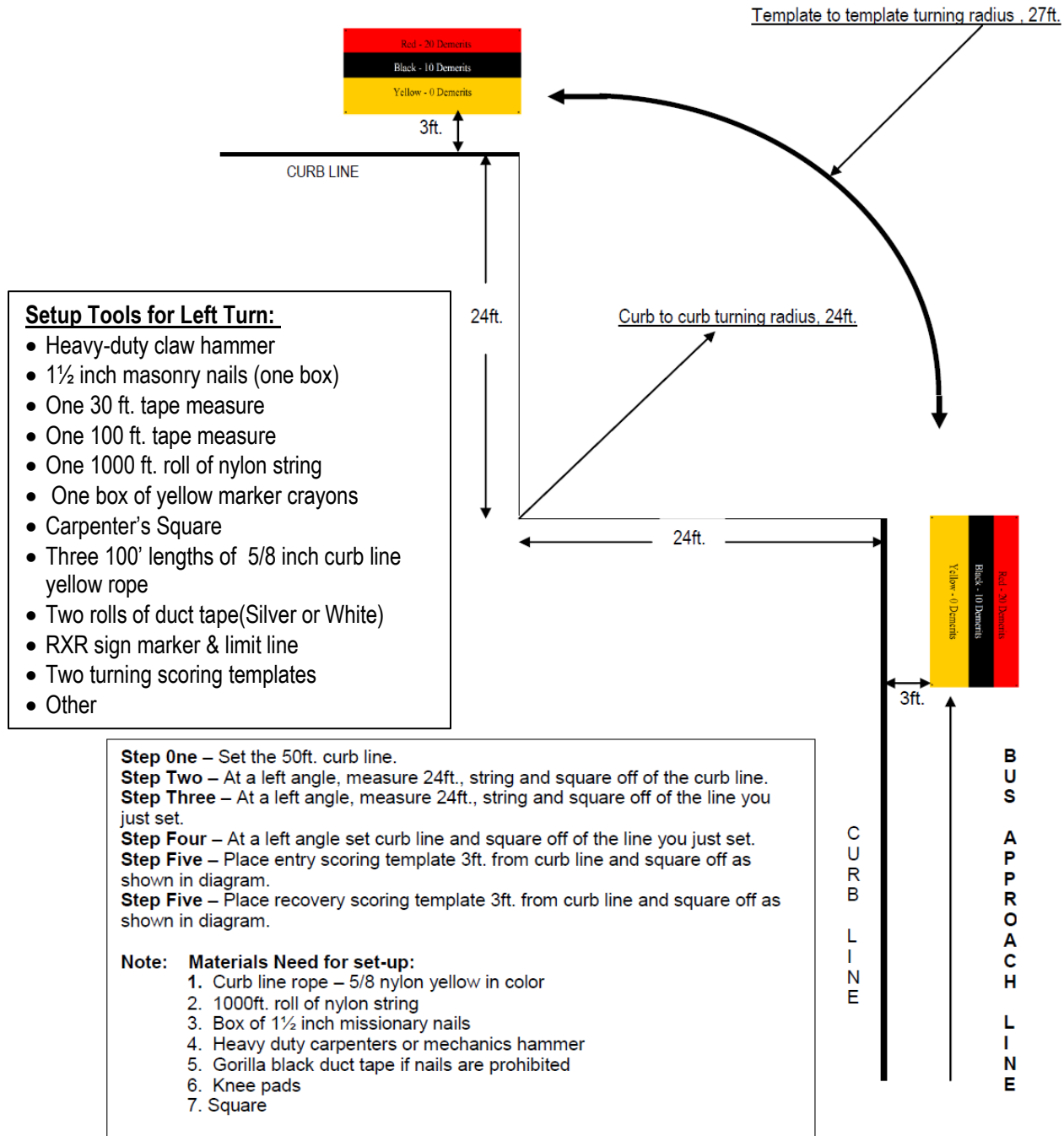

# PARALLEL PARKING EVENT

## LAYOUT & DIRECTIONS:

### Setup Tools for Parallel Parking Stall

- Heavy-duty claw hammer
- 1½ inch masonry nails (one box)
- One 12 ft. tape measure
- One 50 ft. tape measure
- One 1000 ft. roll of nylon string
- One box of yellow marker crayons
- Carpenter's Square
- 50' of 5/8 inch curb line yellow rope
- Other

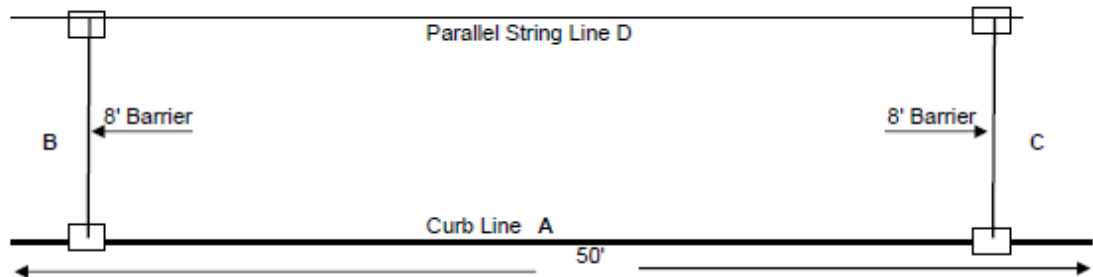

### DIRECTIONS:

1. - Layout the 50' rope curb line "A".
2. - Align the outside edge of the 8' barriers "B" & "C" on curb line "A" at a 90 degree angle.
3. - Layout a parallel string line "D", 8' from curb line "A" at a 90 degree angle to barrier B and C.
4. - Measure and mark along curb line "A" and parallel line "D" the appropriate stall lengths.

#### **Settings for bus stall lengths:**

Transit Bus.....	Length of bus plus 6'
Conventional Bus.....	Length of bus plus 7'
Van type Bus.....	Length of bus plus 7'

5. - Move barrier "B" as necessary for appropriate bus length.

# ELEMENTARY STUDENT LOADING EVENT

## LAYOUT & DIRECTIONS:

### Setup Tools for Elem. Student Loading

- Heavy-duty claw hammer
- 1½ inch masonry nails (one box)
- One 100 ft. tape measure
- One box of yellow marker crayons or chalk
- 50' of 5/8 inch curb line yellow rope
- Student Sign
- Other

1. Layout a 50 ft. curb line rope "A". This will represent the right side of the roadway.
2. Place the Student Sign "B" near the end of and behind the curb line or edge of roadway.
3. Mark where the Student Sign is to be located with crayons or chalk.
4. Make a small crayon or chalk mark "C" 10 ft. from the Student Sign, this will represent the closest the bus can stop from the student.
5. Make a small crayon or chalk mark "D" 15 ft. from the Student Sign which indicates the bus is further than 15 ft. away from the student.

### Elementary Student Loading Event

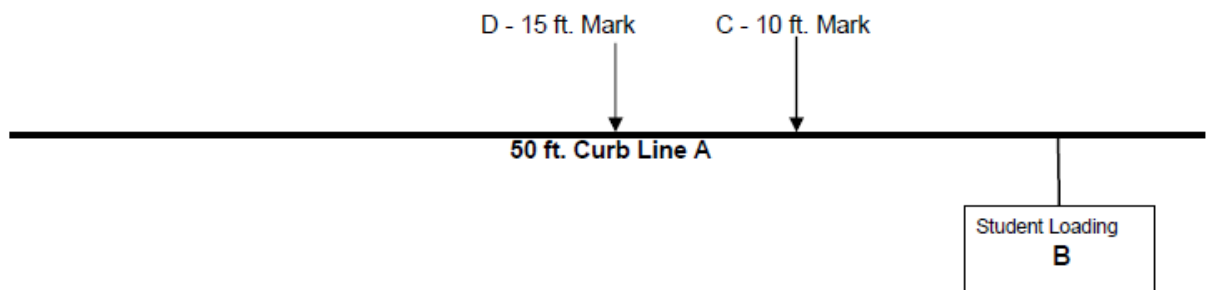

# CURB LINE PARK EVENT

## LAYOUT & DIRECTIONS:

- Setup Tools for Curb Line Parking Stall**
- Heavy-duty claw hammer
  - 1½ inch masonry nails (one box)
  - One 12 ft. tape measure
  - One 100 ft. tape measure
  - One 1000 ft. roll of nylon string
  - One box of yellow marker crayons
  - Carpenter's Square
  - 120' of 5/8 inch curb line yellow rope
  - Other

### Curb Line Parking Layout

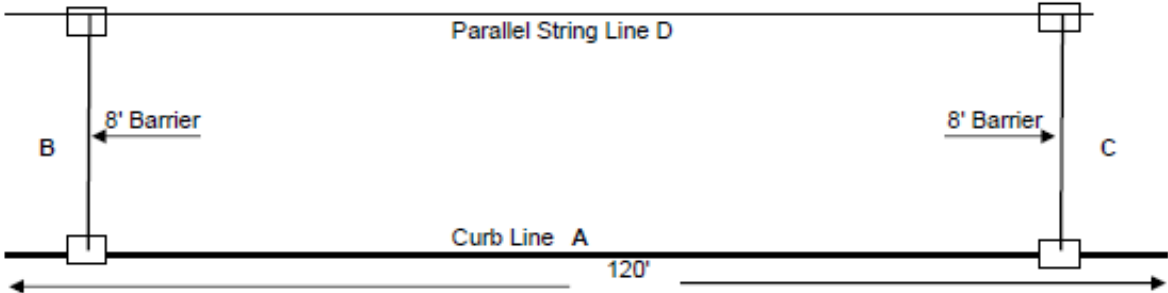

### DIRECTIONS:

1. - Layout the 120' rope curb line "A".
2. - Align the outside edge of the 8' barriers "B" & "C" on curb line "A" at a 90 degree angle.
3. - Layout a parallel string line "D", 8' from curb line "A" at a 90 degree angle to barrier B and C.
4. - Measure and mark along curb line "A" and parallel line "D" the appropriate stall lengths.

**Settings for bus stall lengths:**

- Transit Bus..... 3 times the Length of bus
- Conventional Bus..... 3 times the Length of bus
- Van type Bus..... 3 times the Length of bus

5. - Move barrier "B" as necessary for appropriate bus length.

# **STOP LINE EVENT**

## **LAYOUT DIRECTIONS:**

1. Determine location of stop. Make sure that it does not line up with any ground reference that could be used as a marker.
2. Place a 6 ft. stop line rope on the location determined for the stop line.
3. Place a stop sign on a standard to the right of the line, but not in a location that can be used as a marker or ground reference.

### **Setup Tools for Stop Line Event**

- Heavy-duty claw hammer
- 1½ inch masonry nails (one box)
- One 12 ft. tape measure
- One box of yellow marker crayons
- 6 ft. of 5/8 inch curb line yellow rope
- One stop sign and stand
- Event measuring device

# BUS MEASURING POINTS:

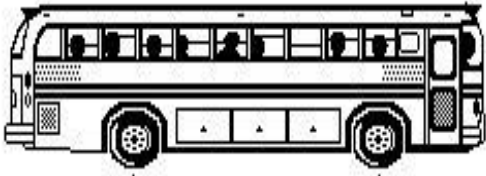

Center & bottom of the tire, both front & rear in relation to the curb line.  
**(Do Not Measure from the Tire Bulge)**



Center & bottom of the rear tire & the widest point of the body just behind the entrance door in relation to the curb line.  
**(Do Not Measure from the Tire Bulge)**

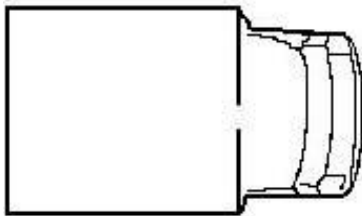

**(WIDE BODY VANS)**  
 The widest part of the body front and rear in relation to the curb line.

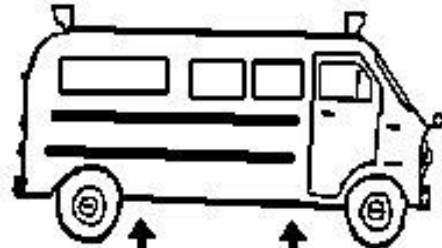

**(FOR ALL OTHER VANS)**  
 The widest part of the body front and rear in relation to the curb line.

## How to use the measuring device

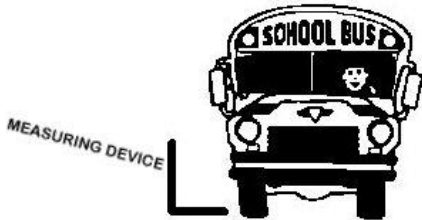

Measuring from the center of the tire tread

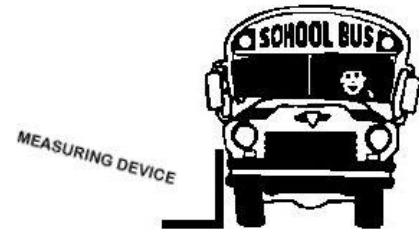

Measuring from the body

**For Events:** Parallel Parking and Curb line Parking